

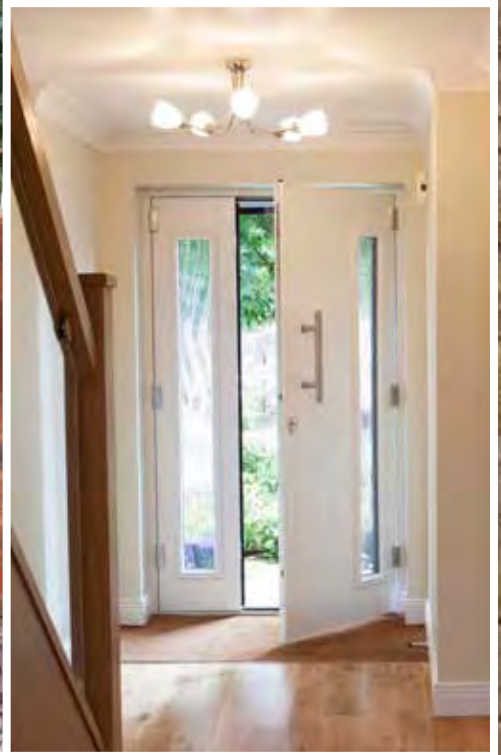

**Solidor®**





2006

BOND HOUSE



Leading the way in secure composite doors



# Introduction

**The Solidor Collection is an outstanding range of industry leading, solid laminate, timber core composite doors. Each Solidor exceeds building regulation requirements and combines traditional and contemporary styling with a full range of Secured by Design locking which provides a stunning, high quality and secure entrance to any home.**

With a thickness of 48mm, a Solidor door is nearly 10% thicker than most alternatives. Each unique solid timber core is completely encapsulated within a highly durable plastic edge banding and two thermo plastic door skins. This means that your customer will never have to worry about painting or varnishing their Solidor.

These doors are exclusively available in the widest range of styles and frame colour options, (20 colours available, please see page 10) with the option of a mobility threshold, making it the perfect solution for easy wheel or push chair access. We offer a comprehensive range of matching combination frames are available with either glass, matching composite side panel or quarter panels, that will complement the look of any property.

Solidor composite doors are manufactured to the highest standards. We hold BSI Kite mark accreditation BSI ISO 9001 for quality management, BSI EN1279 for insulating glass units.

We are also PAS24:2016 certified, hold CE Marking and Secured by design licences, are members of the prestigious GGF and Association of Composite Doors.

## Contents

- 05. Choosing Solidor
- 06. Security
- 08. Colour Options
- 10. The Solidor Promise
- 12. Italia Collection
- 21. London
- 22. Alnwick
- 23. Edinburgh
- 24. Berkeley
- 25. Conway
- 26. Ludlow
- 28. Nottingham
- 29. Harlech
- 30. Tenby
- 31. Beeston
- 32. Flint
- 34. Stafford
- 35. Windsor
- 35. Thornbury
- 36. French Doors
- 38. Stable Doors
- 40. Side Panels
- 42. Glass Options
- 46. Accessories
- 49. Finishing Options

# Choosing Solidor®

**We understand, that knowing your home and family are protected, is a major factor when choosing your new doors.**

You can rest assured that with our door construction, coupled with our unique, reinforced door frame and Secured by Design locking systems, your property will be as safe as can be when you choose Solidor.

## The Comparison



### A typical foam filled construction

- Only a small section of the door is actually solid.
- Thermally good, but foam filled so not solid, nor secure.
- Gel coated GRP may be strong but it scratches very easily and can be cut through.
- Most other doors have frames containing lead stabilisers.
- The frames are only 3 chambers thick and use valuable steel or aluminium reinforcements.
- Can be cut through in 90 seconds

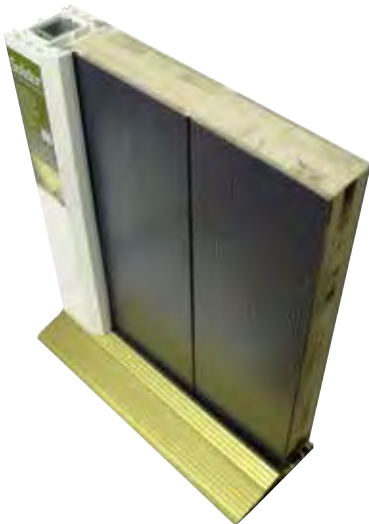

### Solidor® construction

- Lead free, 5 chamber profile with 100% recycled reinforcing.
- Thermally efficient Solid Timber Core.
- Robust through colour thermo plastic skins.
- Realistic wood grain effect or smooth finish.
- Optional integral mobility access aluminium threshold.

**PAS 24  
- 2016  
CERTIFIED**

7/10 COMPOSITE DOORS ARE  
NOT PAS24: - 2016 READY,  
SOLIDOR IS!

To see our security test video visit [www.solidor.co.uk/tv](http://www.solidor.co.uk/tv)



# Security

## The **most secure** composite door on the market



### Lock options

#### The largest deadbolt in the UK

Our exclusive Avantis Secured By Design lock gives you the industry's largest 25.4mm dead bolt for added security. It also has built in compression and dampeners to give the smoothest operation on the market.

#### Key operated multi

If you don't want a handle on your door, you can choose our key operated multi point lock. Cylinder approximately 1060mm from the floor.

#### Key operated slam shut auto

Activates and locks the door automatically once the door is shut. Comes with a thumb turn cylinder as standard, Cylinder approximately 1060mm from the top of the door

#### Heritage automatic slam shut

The aesthetics of a traditional rim latch, but incorporating the latest high security multipoint lock, which activates and locks the door automatically once the door is shut. Comes with a thumb turn cylinder as standard, Cylinder approximately 730mm from the top of the door.

#### Yale Key free

No keys, no hassle, no fuss, all you have to do is remember your PIN number.

The Yale Keyless digital lock lets you choose how you want to open your door: PIN Code, Remote Fob and even from your smartphone when connected to a smart home system. - \*Module for smart home system not included.

#### Supreme security accreditations

Solidor have obtained the highest standards of security and quality.

The **only** hard wood core composite door on the market



# ULTION

Fitted on every Solidor as standard

# STAYS LOCKED



**ULTION MAKES THE UK'S MOST SECURE COMPOSITE DOOR EVEN MORE BURGLAR PROOF**

When it detects attack, a hidden lock within the Ultion automatically engages, so that even when snapped twice nothing gets past it. Leaving a key on the inside of the lock won't affect its performance either.

Ultion has passed tests that even the finest 3 star locks can't achieve, making it the UK's best and most secure lock guaranteed.

  
**£1000  
GUARANTEE**



**IF AN INTRUDER BREAKS INTO YOUR HOME BY SNAPPING  
ULTION WILL PAY YOU £1000**



Molybdenum Alloy Core  
25% denser than Iron

Resistance Sections  
Sacrificed when scrapped



Watch the Ultion v's a standard cylinder video at [www.solidor.co.uk/tv](http://www.solidor.co.uk/tv)

# Choose from 11,000+ Colour Options

We offer the *largest range* of colours from stock in the UK. Choose from *20 colours* inside and/or outside of the door, with *18 frame combinations*.

## RAL Colour Match

for Solidor Door Skins

**White Skins** - RAL 9016

**Blue Skins** - RAL 5011

**Green Skins** - RAL 6009

**Red Skins** - RAL 3011

**Black Skins** - RAL 9005

**Anthracite Grey** - RAL 7016

**French Grey** - RAL 7001

**Rich Aubergine** - RAL 4007

**Painswick** - RAL 7038

**Cream** - RAL 9001

**Foiled White** - RAL 9010

**Schwarzbraun** - RAL 8022

**Chartwell Green**

RAL 6021 (not a perfect match)  
or BS14C35 Iceplant Green

**Duck Egg Blue**

BRITISH STANDARD RANGE  
4800/5252 REF 20-C-33

**Irish Oak** - Foiled Material

**Golden Oak** - Foiled Material

**Rosewood** - Foiled Material

**Walnut** - Foiled Material

**Peacock Blue** - BS381C103

**Golden Sand** - - RAL 1002

✱ Available as a door and/or  
a frame option

## Be inspired...

Introducing 2 brand new colour finishes for your Solidor. The best colour for your door depends a lot on the style of your house, but as a guide, traditional homes generally suit rich colours such as Peacock Blue, while modern homes suit more contemporary shades, such as warm greys or our 'Golden Sand'

With Solidor, you can mix and match! For example, Chartwell Green on White outer frame with Duck Egg Blue on French Grey door.

New!

Luxury Range  
Peacock Blue

Luxury Range  
Golden Sand

Luxury Range  
Duck Egg Blue

Luxury Range  
Walnut

Luxury Range  
Painswick



\*Due to the limitations of the lithographic printing process, colour samples may not be an exact match to actual doors.



# The Solidor Promise

At Solidor we are committed to doing our part in helping the environment, believing that the future of our planet is important, not only for ourselves, but for the future of our children. With many industry firsts already, we are always looking to pioneer greener products and methods.

That's why we minimise our waste and run an extensive recycling programme. We recycle all of our packaging, polystyrene, cardboard, PVC-u, timber, paper, aluminium and steel. All of the timbers used in our doors are harvested from forests which are managed to meet the social, economic and ecological needs of present and future generations.

## Our Green Credentials

Timber can make a significant contribution to sustainable construction

1. Wood is naturally renewable
2. It is independently certified to be sourced from sustainably managed forests
3. Doors with timber cores save energy
4. They last longer
5. They add to our quality of life
6. They have fewer environmental impacts than other materials
7. Complies with minimum U-value requirements for building regulations



- 100% recycled thermally efficient reinforcing system
- 5 chamber lead free thermally efficient profile
- Extensive recycling programme
- Door can be recycled at the end of its useful life, not destined for land fill
- Fully manufactured in the UK to minimise our carbon footprint
- Lead free door skins and edge banding



CONTEMPORARY

# Italia Collection

The Italia collection from Solidor, is a new generation of truly contemporary designs which will add a touch of style to your home. Carefully designed and crafted from the finest materials, every door in the Italia collection has a definite style inspired by the Italian passion for design.

Each door is handmade in Staffordshire, ensuring the finished product is of an outstanding quality and made as individual as can be. Choose from a range of glass styles and door furniture which have been carefully chosen with the latest fashion and designs in mind. All of the doors in the Italia Collection are also available with Warwick Glass - hand made so no two pieces are ever the same.

As with any product from Solidor, you can be assured of the outstanding quality of our solid laminate 48mm timber core composite doors which combine modern styling with high security locking systems.

# Milano

Milano in Anthracite Grey with ES3 1800 door handle and key only security locking option

All Italia doors are available with or without grooves



# Brescia

Brescia in French Grey with ES3 1800 door handle and key only security locking option



# Genoa

Genoa in Golden Oak, ES3 800 door handle and key only security locking option.



# Sorrento

Sorrento in Cream with ES3 400 door handle and key only security locking option

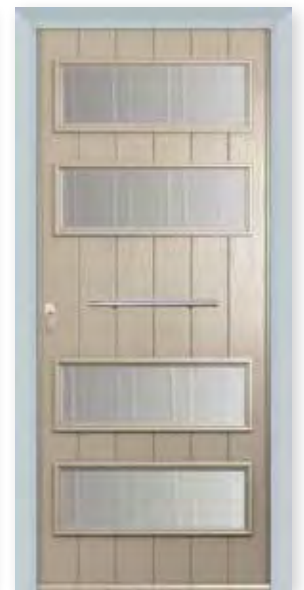

Red	Green	Blue	Black	White	Duck Egg Blue	Walnut	Irish Oak	Rich Aubergine	Chartwell Green
French Grey	Foiled White	Anthracite Grey	Golden Oak	Schwarzbraun	Rosewood	Cream	Peacock Blue	Golden Sand	Painswick

# Amalfi

Amalfi in Golden Sand with Matrix glass and ES21 door handle



# Modena

Modena in Anthracite Grey with ES24 door handle and key only security locking option



# Siena

Siena in Luxury Walnut with ES23 door handle, abstract glass and key only security locking option



# Pisa

Pisa in Chartwell Green with ES23 door handle, abstract glass and key only security locking option



# Parma

Parma in Schwarzbraun, with ES3 1800 door handle, Potomac glass and key only security locking option

All Italia doors are available with or without grooves



# Messina

Messina in Rosewood, ES3 800 door handle and key only security locking option



# Venice

Venice in Peacock Blue and Warwick glass with ES3 1800 door handle and key only security locking option



# Garda

Garda in Painswick, with ES24 door handle, solid stainless steel knocker, Satin glass and key only security locking option



Red	Green	Blue	Black	White	Duck Egg Blue	Walnut	Irish Oak	Rich Aubergine	Chartwell Green
French Grey	Foiled White	Anthraccite Grey	Golden Oak	Schwarzbraun	Rosewood	Cream	Peacock Blue	Golden Sand	Painswick

# Palermo

Palermo in Luxury Walnut with ES3 1800 door handle\*



## Naples

Naples in Schwarzbraun with Bullseye glass. Chrome finish handle with multipoint locking option.



## Biella

Biella in Foiled White with chrome lever handle and multi point locking



# Rimini

Rimini in Irish Oak, with ES3 1800 door handle, Satin glass and key only security locking option

All Italia doors are available with or without grooves



# Roma

Roma in Golden Sand with Bullseye glass, ES21 door handle and key only security locking option



# Monza

Monza in Painswick with ES21 door handle, Satin glass and key only security locking option



# Ancona Solid

Ancona Solid in Golden Oak with ES3 1800 door handle and key only security locking option



Red	Green	Blue	Black	White	Duck Egg Blue	Walnut	Irish Oak	Rich Aubergine	Chartwell Green
French Grey	Foiled White	Anthracite Grey	Golden Oak	Schwarzbraun	Rosewood	Cream	Peacock Blue	Golden Sand	Painswick



# Bologna

Bologna in Painswick with Bullseye glass, ES 24 door handle and key only security locking option



# Turin

Turin in Chartwell Green with Abstract glass, Chrome finish handle and multi point locking



# Ancona

Ancona in Cream and CTB18.1 glass with EK53 door handle and key only security locking option



# Verona

Verona Solid in Duck Egg Blue with ES3 1800 door handle and key only security locking option. Available with grooves



# Contemporary Italia Glass (see pages 42-45)

	Garda	Amalfi	Ancona	Biella	Bologna	Brescia	Messina	Milano	Naples	Palermo	Pisa	Roma	Sienna	Sorrento	Turin	Monza	Parma	Rimini
Abstract										✓		✓		✓				
Brillante														✓				
Bullseye						✓	✓				✓							
CFT 2.1														✓				
Clarity - Gold only														✓				
CTB 17.1														✓				
CTB 19.1														✓				
Diamond Glass														✓				
Elegance														✓				
Etched Squared		✓				✓												
Jewel														✓				
Linear						✓												
Matrix		✓				✓												
Modena																✓		
Park Lane Bespoke																✓		
Potomac														✓	✓	✓		
Prarie														✓				
Quad Glass														✓				
Reflections														✓	✓			
Royale														✓				
Simplicity														✓				
Trio Square Glass														✓				

**Diamond Glass** available in Red / Black / Butterscotch / Black and White

**Quad Glass** available in Red / Black / Blue / Grey

**Trio Square Glass** available in Red / Black / Blue / Butterscotch / Green / Grey / Sea Green

# Contemporary Italia Accessories

Designer handle range for our key only operated and slam shut auto locks

With all of our designer handles, the inside of the door will be fitted with the EK53 pull unless a back to back option is chosen at an additional cost



ES3 800mm



ES24



ES23



ES3 1800mm

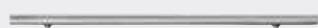

ES3 800mm

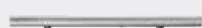

ES3 400mm



ES21



ES24



EK53



ES23

This information is intended for illustration purposes only and may be subject to change for reasons beyond our control. As a consequence this brochure should be used for guidance only.

## Pilkington Texture Glass Warwick™

This design is unique amongst our patterns because it is produced using a different manufacturing method. Pilkington Texture Glass Warwick™ is a random pattern that is added along the central portion of the pane and this has implications when cutting the glass down into finished sizes. It is possible, if a pane is small enough, it could be cut with no evidence of the pattern at all.

None of the Pilkington patterns are designed to have an orientation (an up side) but care needs to be taken with adjacent panes that the pattern direction is maintained. There is a linear nature to Pilkington Texture Glass Warwick™ and so householders should be aware that there could be aesthetic implications when choosing this design. Also, for the glass supplier the result may be that this pattern is less accommodating when cutting and may result in a greater proportion of seldge from the original glass plate.



Warwick Glass available in all of our doors



Abstract Glass available in the Pisa, Turin and Siena



Satin Glass available in all of our doors



# Traditional Collection

The Heritage collection from Solidor, brings classic designs into the modern era. Each door design is suited to both traditional and modern properties alike, and will add a touch of elegance to every home.

# London

Its timeless beauty is down to its most distinguishing feature; the arched glazed panel

## Glass Options

(see pages 42-45)

### NEW GLASS

Caledonian Rose Handed

Dorchester

Etched Squares

Linear

London Etch Border

Matrix

Modena

Park Lane Bespoke

Zinc Art Star

Abstract

Blind

Brilliante

CFT 2.1

CFT 2.2

CGB - B

CGB - F

Clarity

CSB 5.1FT

CTB 12.1

CTB 12.3

CTB 12.3BG

CTB 17.1

CTB 17.2

CTB 18.1

CTB 19.1

CTB 19.2

CTL 3.1

CTL 6.1

CTL 31.1B

CTL 31.2B

Diamond (Black & White)

Diamond (Black)

Diamond (Butterscotch)

Diamond (Red)

Diamond Lead

Duplex B2B - Geo Cassette

Elegance

GB (Brown)

GB (Oak)

GB (Rosewood)

GB (White)

Jewel

Potomac

Prairie

Quad (Black)

Quad (Blue)

Quad (Grey)

Quad (Red)

Reflections

Royale

Simplicity

Square Lead

Star Black

Star Clear

Trio Square (Red)

Trio Square (Black)

Trio Square (Blue)

Trio Square (Butterscotch)

Trio Square (Green)

Trio Square (Grey)

Trio Square (Sea Green)



London - Peacock Blue - Caledonian Rose



London Golden Sand - Satin



London French Grey - Park Lane



London Golden Oak - Dorchester

Red	Green	Blue	Black	White	Duck Egg Blue	Walnut	Irish Oak	Rich Aubergine	Chartwell Green
French Grey	Foiled White	Anthracite Grey	Golden Oak	Schwarzbraun	Rosewood	Cream	Peacock Blue	Golden Sand	Painswick

# Alnwick

Makes for a great alternative to traditional designs and allows maximum natural light

## Glass Options

(see pages 42-45)

### NEW GLASS

Caledonian Rose Handed	CTB 12.3	GB (White)
Dorchester	CTB 12.3BG	Jewel
Etched Squares	CTB 17.1	Potomac
Linear	CTB 17.2	Prairie
London Etch Border	CTB 18.1	Quad (Black)
Matrix	CTB 19.1	Quad (Blue)
Modena	CTB 19.2	Quad (Grey)
Park Lane Bespoke	CTL 3.1	Quad (Red)
Zinc Art Star	CTL 6.1	Reflections
	CTL 31.1B	Royale
	CTL 31.2B	Simplicity
	Diamond (Black & White)	Square Lead
	Diamond (Black)	Star Black
	Diamond (Butterscotch)	Star Clear
	Diamond (Red)	Trio Square (Red)
	Diamond Lead	Trio Square (Black)
	Duplex B2B - Geo Cassette	Trio Square (Blue)
	Elegance	Trio Square (Butterscotch)
	GB (Brown)	Trio Square (Green)
	GB (Oak)	Trio Square (Grey)
	GB (Rosewood)	Trio Square (Sea Green)
Abstract		
Blind		
Brilliante		
CFT 2.1		
CFT 2.2		
CGB - B		
CGB - F		
Clarity		
CSB 5.1FT		
CTB 12.1		



Alnwick - Schwarzbraun - Park Lane



Alnwick  
Anthracite Grey - Satin



Alnwick  
Rich Aubergine - Warwick



Alnwick  
Chartwell Green - Modena

Red	Green	Blue	Black	White	Duck Egg Blue	Walnut	Irish Oak	Rich Aubergine	Chartwell Green
French Grey	Foiled White	Anthracite Grey	Golden Oak	Schwarzbraun	Rosewood	Cream	Peacock Blue	Golden Sand	Painswick

# Edinburgh

A wonderful alternative to the classic Victorian four panel door style, thanks to its two elongated glazed units



Edinburgh - Peacock Blue - Satin



Edinburgh  
Golden Sand



Edinburgh  
Cream



Edinburgh  
Anthracite Grey

Red	Green	Blue	Black	White	Duck Egg Blue	Walnut	Irish Oak	Rich Aubergine	Chartwell Green
French Grey	Foiled White	Anthracite Grey	Golden Oak	Schwarzbraun	Rosewood	Cream	Peacock Blue	Golden Sand	Painswick

# Berkeley

Contains two immaculately styled glazed units to help entice the natural light of the sun

## Glass Options

(see pages 42-45)

### NEW GLASS

Caledonian Rose Handed

Dorchester

Etched Squares

Linear

London Etch Border

Matrix

Modena

Park Lane Bespoke

Zinc Art Star

Abstract

Blind

Brilliante

CFT 2.1

CFT 2.2

CGB - B

CGB - F

Clarity

CSB 5.1FT

CTB 12.1

CTB 12.3

CTB 12.3BG

CTB 17.1

CTB 17.2

CTB 18.1

CTB 19.1

CTB 19.2

CTL 3.1

CTL 6.1

CTL 31.1B

CTL 31.2B

Diamond (Black & White)

Diamond (Black)

Diamond (Butterscotch)

Diamond (Red)

Diamond Lead

Duplex B2B - Geo Cassette

Elegance

GB (Brown)

GB (Oak)

GB (Rosewood)

GB (White)

Jewel

Potomac

Prairie

Quad (Black)

Quad (Blue)

Quad (Grey)

Quad (Red)

Reflections

Royale

Simplicity

Square Lead

Star Black

Star Clear

Trio Square (Red)

Trio Square (Black)

Trio Square (Blue)

Trio Square (Butterscotch)

Trio Square (Green)

Trio Square (Grey)

Trio Square (Sea Green)



Berkeley - Red - Matrix



Berkeley  
Blue - Satin



Berkeley  
Walnut - Caledonian Rose



Berkeley  
Duck Egg Blue - Dorchester

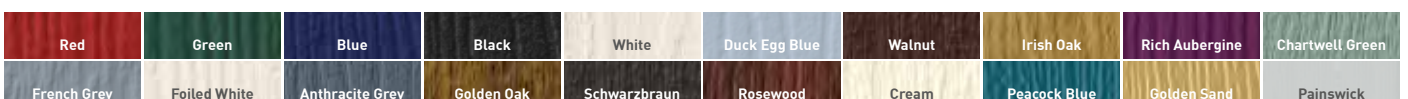



# Conway

Sympathetically styled to complement most properties, from period to modern

## Glass Options

(see pages 42-45)

### NEW GLASS

Caledonian Rose Handed	✓
Dorchester	✓
Etched Squares	
Linear	
London Etch Border	
Matrix	
Modena	
Park Lane Bespoke	
Zinc Art Star	✓
Abstract	✓
Blind	
Brilliante	
CFT 2.1	
CFT 2.2	
CGB - B	
CGB - F	✓
Clarity	✓
CSB 5.1FT	✓
CTB 12.1	✓

CTB 12.3	✓
CTB 12.3BG	✓
CTB 17.1	
CTB 17.2	
CTB 18.1	
CTB 19.1	
CTB 19.2	
CTL 3.1	
CTL 6.1	✓
CTL 31.1B	
CTL 31.2B	
Diamond (Black & White)	✓
Diamond (Black)	✓
Diamond (Butterscotch)	✓
Diamond (Red)	✓
Diamond Lead	
Duplex B2B - Geo Cassette	
Elegance	✓
GB (Brown)	
GB (Oak)	
GB (Rosewood)	

GB (White)	
Jewel	
Potomac	
Prairie	✓
Quad (Black)	✓
Quad (Blue)	✓
Quad (Grey)	✓
Quad (Red)	✓
Reflections	✓
Royale	✓
Simplicity	✓
Square Lead	
Star Black	
Star Clear	
Trio Square (Red)	✓
Trio Square (Black)	✓
Trio Square (Blue)	✓
Trio Square (Butterscotch)	
Trio Square (Green)	
Trio Square (Grey)	✓
Trio Square (Sea Green)	



Conway 3 - Foiled White - Caledonian Rose



Conway Solid  
Rosewood



Conway 1  
Peacock Blue - Elegance



Conway 3  
Golden Sands - Diamond Black

Red	Green	Blue	Black	White	Duck Egg Blue	Walnut	Irish Oak	Rich Aubergine	Chartwell Green
French Grey	Foiled White	Anthracite Grey	Golden Oak	Schwarzbraun	Rosewood	Cream	Peacock Blue	Golden Sand	Painswick

# Ludlow

This is our most popular door style which complements almost any property



Ludlow 2 - Painswick - London Etch Border



Ludlow 2 - Peacock Blue - Dorchester

Red	Green	Blue	Black	White	Duck Egg Blue	Walnut	Irish Oak	Rich Aubergine	Chartwell Green
French Grey	Foiled White	Anthracite Grey	Golden Oak	Schwarzbraun	Rosewood	Cream	Peacock Blue	Golden Sand	Painswick

# Glass Options

(see pages 42-45)

## NEW GLASS

Caledonian Rose Handed	✓	CGB - B	Diamond (Black & White)	✓	Quad (Grey)	✓	
Dorchester	✓	CGB - F	Diamond (Black)	✓	Quad (Red)	✓	
Etched Squares	✓	Clarity	✓	Diamond (Butterscotch)	✓	Reflections	✓
Linear	✓	CSB 5.1FT	Diamond (Red)	✓	Royale		
London Etch Border	✓	CTB 12.1	Diamond Lead	✓	Simplicity	✓	
Matrix	✓	CTB 12.3	Duplex B2B - Geo Cassette		Square Lead	✓	
Modena	✓	CTB 12.3BG	Elegance	✓	Star Black		
Park Lane Bespoke	✓	CTB 17.1	GB (Brown)		Star Clear		
Zinc Art Star	✓	CTB 17.2	✓	GB (Oak)	Trio Square (Red)	✓	
		CTB 18.1	GB (Rosewood)		Trio Square (Black)	✓	
		CTB 19.1	GB (White)		Trio Square (Blue)	✓	
Abstract	✓	CTB 19.2	Jewel	✓	Trio Square (Butterscotch)		
Blind		CTL 3.1	Potomac	✓	Trio Square (Green)		
Brilliante	✓	CTL 6.1	Prairie	✓	Trio Square (Grey)	✓	
CFT 2.1		CTL 31.1B	Quad (Black)	✓	Trio Square (Sea Green)		
CFT 2.2	✓	CTL 31.2B	✓	Quad (Blue)	✓		



**Ludlow 2**  
Rich Aubergine - Etched Square



**Ludlow 2**  
Anthracite Grey - Brilliante



**Ludlow 2**  
Golden Oak - Quad Grey

# Nottingham

A unique door with real appeal for traditional properties with arched features

## Glass Options

(see pages 42-45)

### NEW GLASS

Caledonian Rose Handed	✓	CTB 12.3	GB (White)
Dorchester		CTB 12.3BG	Jewel
Etched Squares		CTB 17.1	Potomac
Linear		CTB 17.2	Prairie
London Etch Border		CTB 18.1	Quad (Black)
Matrix		CTB 19.1	Quad (Blue)
Modena		CTB 19.2	Quad (Grey)
Park Lane Bespoke	✓	CTL 3.1	Quad (Red)
Zinc Art Star	✓	CTL 6.1	Reflections
Abstract	✓	CTL 31.1B	Royale
Blind		CTL 31.2B	Simplicity
Brilliante	✓	Diamond (Black & White)	Square Lead
CFT 2.1		Diamond (Black)	Star Black
CFT 2.2	✓	Diamond (Butterscotch)	Star Clear
CGB - B		Diamond (Red)	Trio Square (Red)
CGB - F		Diamond Lead	Trio Square (Black)
Clarity	✓	Duplex B2B - Geo Cassette	Trio Square (Blue)
CSB 5.1FT		Elegance	Trio Square (Butterscotch)
CTB 12.1		GB (Brown)	Trio Square (Green)
		GB (Oak)	Trio Square (Grey)
		GB (Rosewood)	Trio Square (Sea Green)



Nottingham - Chartwell Green - Simplicity



Nottingham  
Red - Quad Black



Nottingham  
French Grey - Brilliante



Nottingham  
Schwarzbraun - CTB 19.2

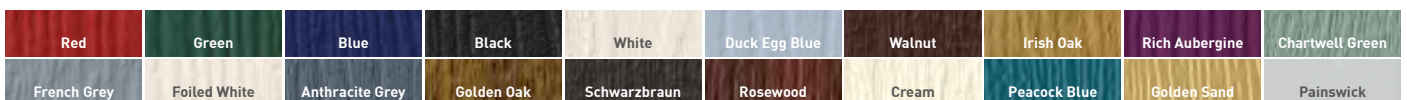

# Harlech

A very popular choice for properties with gable end features

## Glass Options

(see pages 42-45)

### NEW GLASS

Caledonian Rose Handed

Dorchester

Etched Squares

Linear

London Etch Border

Matrix

Modena

Park Lane Bespoke

Zinc Art Star

Abstract

Blind

Brilliante

CFT 2.1

CFT 2.2

CGB - B

CGB - F

Clarity

CSB 5.1FT

CTB 12.1

CTB 12.3

CTB 12.3BG

CTB 17.1

CTB 17.2

CTB 18.1

CTB 19.1

CTB 19.2

CTL 3.1

CTL 6.1

CTL 31.1B

CTL 31.2B

Diamond (Black & White)

Diamond (Black)

Diamond (Butterscotch)

Diamond (Red)

Diamond Lead

Duplex B2B - Geo Cassette

Elegance

GB (Brown)

GB (Oak)

GB (Rosewood)

GB (White)

Jewel

Potomac

Prairie

Quad (Black)

Quad (Blue)

Quad (Grey)

Quad (Red)

Reflections

Royale

Simplicity

Square Lead

Star Black

Star Clear

Trio Square (Red)

Trio Square (Black)

Trio Square (Blue)

Trio Square (Butterscotch)

Trio Square (Green)

Trio Square (Grey)

Trio Square (Sea Green)



Harlech 2 - French Grey - Zinc Art Star



Harlech 2  
Black - Diamond Black

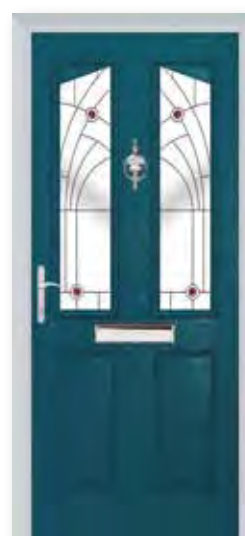

Harlech 2  
Peacock Blue - Jewel



Harlech 2  
Walnut - CTB 17.2

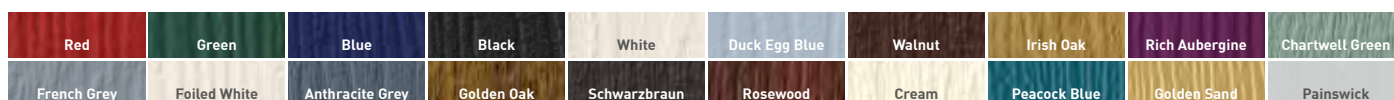

# Tenby

A timeless classic of a design which will complement every home

## Glass Options

(see pages 42-45)

### NEW GLASS

Caledonian Rose Handed	✓
Dorchester	✓
Etched Squares	
Linear	
London Etch Border	
Matrix	✓
Modena	✓
Park Lane Bespoke	
Zinc Art Star	✓

Abstract	
Blind	
Brilliante	
CFT 2.1	
CFT 2.2	
CGB - B	
CGB - F	
Clarity	
CSB 5.1FT	
CTB 12.1	

CTB 12.3	
CTB 12.3BG	
CTB 17.1	
CTB 17.2	
CTB 18.1	
CTB 19.1	
CTB 19.2	
CTL 3.1	
CTL 6.1	
CTL 31.1B	
CTL 31.2B	
Diamond (Black & White)	
Diamond (Black)	
Diamond (Butterscotch)	
Diamond (Red)	
Diamond Lead	✓
Duplex B2B - Geo Cassette	
Elegance	✓
GB (Brown)	
GB (Oak)	
GB (Rosewood)	

GB (White)	
Jewel	
Potomac	
Prairie	✓
Quad (Black)	✓
Quad (Blue)	✓
Quad (Grey)	✓
Quad (Red)	✓
Reflections	
Royale	
Simplicity	
Square Lead	✓
Star Black	✓
Star Clear	
Trio Square (Red)	
Trio Square (Black)	
Trio Square (Blue)	
Trio Square (Butterscotch)	
Trio Square (Green)	
Trio Square (Grey)	
Trio Square (Sea Green)	



Tenby 4 - Schwarzbraun - Modena



Tenby 4  
Painswick - Quad Grey



Tenby 2  
Rich Aubergine - Reflections



Tenby 2  
Duck Egg Blue - Caledonian Rose

Red	Green	Blue	Black	White	Duck Egg Blue	Walnut	Irish Oak	Rich Aubergine	Chartwell Green
French Grey	Foiled White	Anthracite Grey	Golden Oak	Schwarzbraun	Rosewood	Cream	Peacock Blue	Golden Sand	Painswick

# Beeston

A great choice for a front or back door, the most popular choice as a stable door

## Glass Options

(see pages 42-45)

### NEW GLASS

Caledonian Rose Handed

Dorchester

Etched Squares

Linear

London Etch Border

Matrix

Modena

Park Lane Bespoke

Zinc Art Star

Abstract

Blind

Brilliante

CFT 2.1

CFT 2.2

CGB - B

CGB - F

Clarity

CSB 5.1FT

CTB 12.1

CTB 12.3

CTB 12.3BG

CTB 17.1

CTB 17.2

CTB 18.1

CTB 19.1

CTB 19.2

CTL 3.1

CTL 6.1

CTL 31.1B

CTL 31.2B

Diamond (Black & White)

Diamond (Black)

Diamond (Butterscotch)

Diamond (Red)

Diamond Lead

Duplex B2B - Geo Cassette

Elegance

GB (Brown)

GB (Oak)

GB (Rosewood)

GB (White)

Jewel

Potomac

Prairie

Quad (Black)

Quad (Blue)

Quad (Grey)

Quad (Red)

Reflections

Royale

Simplicity

Square Lead

Star Black

Star Clear

Trio Square (Red)

Trio Square (Black)

Trio Square (Blue)

Trio Square (Butterscotch)

Trio Square (Green)

Trio Square (Grey)

Trio Square (Sea Green)



Beeston 1 - White - Reflections



Beeston GB  
Duck Egg Blue - Satin



Beeston 1  
Rosewood - Integrated Blind

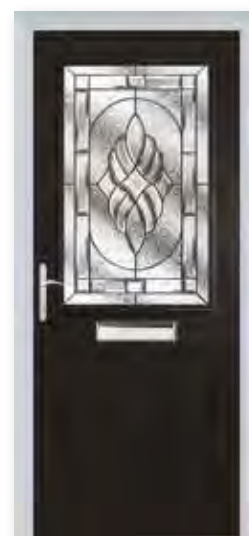

Beeston 1  
Black - Elegance

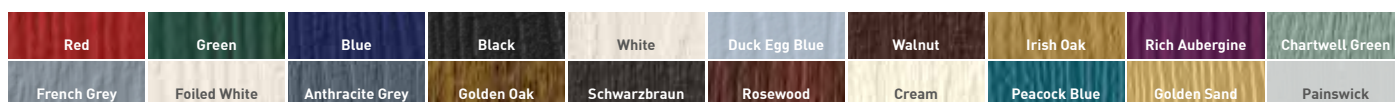

# Traditional Flint

A great option for cottages, farmhouses, side doors and stable doors

## Glass Options

(see pages 42-45)

	Flint 1	Flint 2	Flint 3	Flint 4	Flint 5	Square
Abstract			✓			
Black Star	✓		✓			✓
Brilliante			✓			
Bullseye	✓		✓			✓
Clarity			✓			
Clear Star	✓		✓			✓
CTB 17.1			✓			
CTB 18.1		✓				
CTB 19.1			✓			
CTF 2.1			✓			
CTL 31.1B			✓			
Diamond Glass			✓			
Elegance			✓			
Jewel			✓			
London Etch Border	✓					✓
Modena				✓		
Park Lane Bespoke			✓	✓		
Potomac			✓	✓		
Prairie			✓			
Quad Glass			✓			
Reflections			✓	✓		
Simplicity			✓			
Trio Square Group 1	✓		✓			✓
Trio Square Group 2			✓			



Flint Solid - Duck Egg Blue



Flint 1  
Anthracite Grey - Bullseye

**Diamond Glass** available in  
Red / Black / Butterscotch / Black & White

**Quad Glass** available in  
Red / Black / Blue / Grey

**Trio Square Glass Group 1** available in  
Butterscotch / Green / Sea Green

**Trio Square Glass Group 2** available in  
Red / Black / Blue / Grey

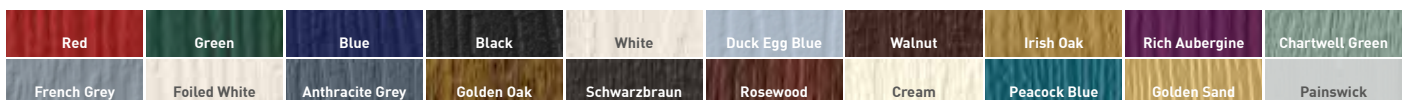





**Flint 2**  
Golden Sand - CTB18.1



**Flint 3**  
Chartwell Green - Trio Square Green



**Flint 4**  
Golden Oak - Park Lane



**Flint 5**  
Painswick - Modena



**Flint Square**  
Peacock Blue - Bullseye



**Flint Beeston - Without grooves**  
Red - Brillante

# Stafford

A stylish alternative for any door and looks great on any property

## Glass Options

(see pages 42-45)

### NEW GLASS

Caledonian Rose Handed	CTB 12.3	GB (White)
Dorchester	CTB 12.3BG	Jewel <input checked="" type="checkbox"/>
Etched Squares	CTB 17.1	Potomac
Linear	CTB 17.2	Prairie
London Etch Border	CTB 18.1	Quad (Black) <input checked="" type="checkbox"/>
Matrix	CTB 19.1	Quad (Blue) <input checked="" type="checkbox"/>
Modena <input checked="" type="checkbox"/>	CTB 19.2	Quad (Grey) <input checked="" type="checkbox"/>
Park Lane Bespoke <input checked="" type="checkbox"/>	CTL 3.1	Quad (Red) <input checked="" type="checkbox"/>
Zinc Art Star <input checked="" type="checkbox"/>	CTL 6.1	Reflections
Abstract <input checked="" type="checkbox"/>	CTL 31.1B	Royale <input checked="" type="checkbox"/>
Blind	CTL 31.2B	Simplicity <input checked="" type="checkbox"/>
Brilliante <input checked="" type="checkbox"/>	Diamond (Black & White) <input checked="" type="checkbox"/>	Square Lead <input checked="" type="checkbox"/>
CFT 2.1	Diamond (Black) <input checked="" type="checkbox"/>	Star Black
CFT 2.2	Diamond (Butterscotch) <input checked="" type="checkbox"/>	Star Clear
CGB - B	Diamond (Red) <input checked="" type="checkbox"/>	Trio Square (Red) <input checked="" type="checkbox"/>
CGB - F	Diamond Lead <input checked="" type="checkbox"/>	Trio Square (Black)
Clarity <input checked="" type="checkbox"/>	Duplex B2B - Geo Cassette	Trio Square (Blue)
CSB 5.1FT	Elegance <input checked="" type="checkbox"/>	Trio Square (Butterscotch) <input checked="" type="checkbox"/>
CTB 12.1	GB (Brown)	Trio Square (Green) <input checked="" type="checkbox"/>
	GB (Oak)	Trio Square (Grey)
	GB (Rosewood)	Trio Square (Sea Green) <input checked="" type="checkbox"/>



Stafford 1 - Schwarzbraun - Park Lane



Stafford 2  
French Grey - Royale



Stafford 2  
Foiled White - Elegance



Stafford 1  
Rich Aubergine - Clarity

Red	Green	Blue	Black	White	Duck Egg Blue	Walnut	Irish Oak	Rich Aubergine	Chartwell Green
French Grey	Foiled White	Anthracite Grey	Golden Oak	Schwarzbraun	Rosewood	Cream	Peacock Blue	Golden Sand	Painswick

# Windsor

A great option for modern and traditional properties alike



**Windsor** - Golden Sand



**Windsor Glazed** - French Grey

# Thornbury

Add an elegant yet subtle finish to any entrance



**Thornbury** - Schwarzbraun

Red	Green	Blue	Black	White	Duck Egg Blue	Walnut	Irish Oak	Rich Aubergine	Chartwell Green
French Grey	Foiled White	Anthracite Grey	Golden Oak	Schwarzbraun	Rosewood	Cream	Peacock Blue	Golden Sand	Painswick

# French Doors

BOND HOUSE

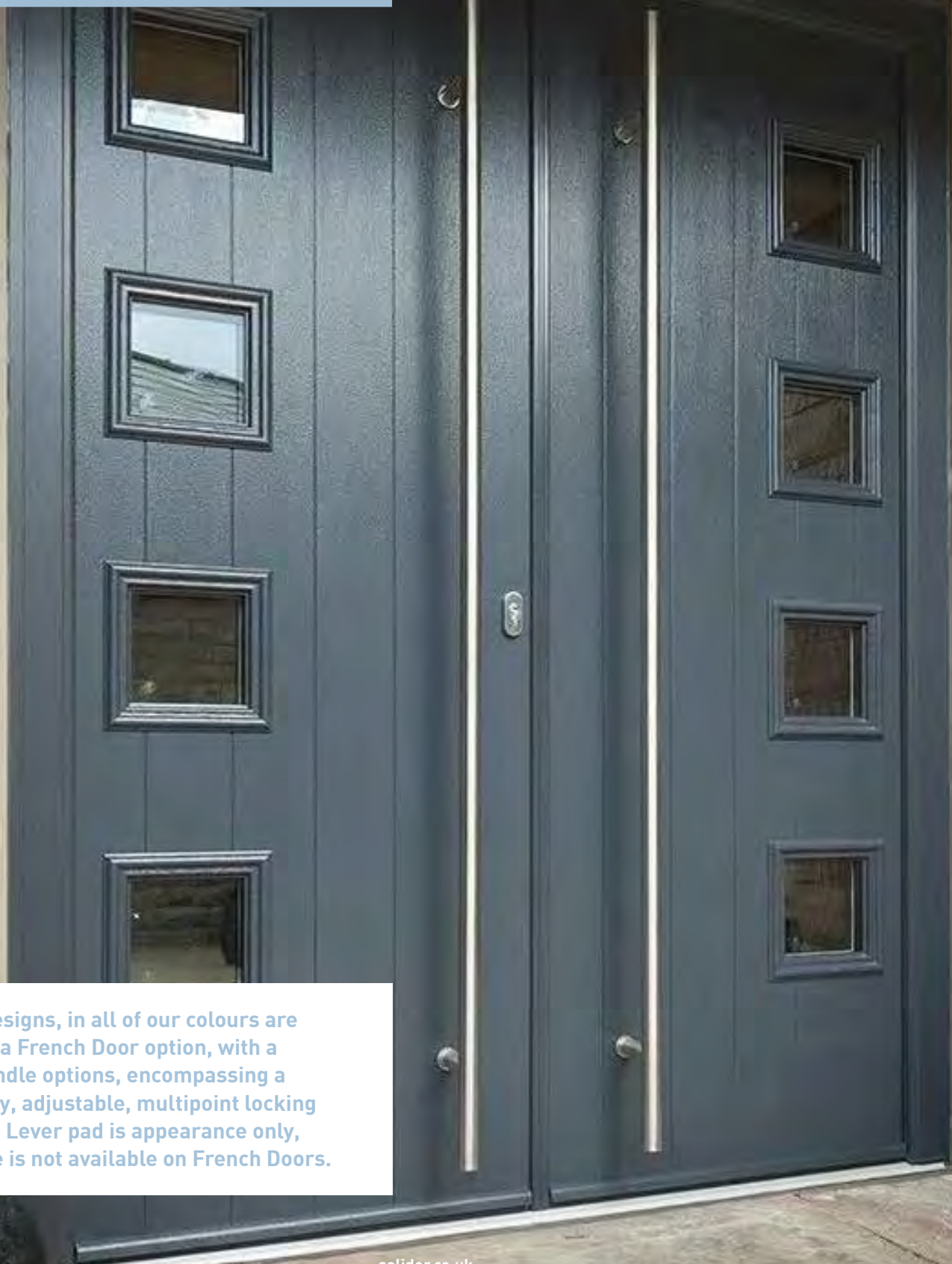

All of our designs, in all of our colours are available in a French Door option, with a range of handle options, encompassing a high security, adjustable, multipoint locking system. N.B Lever pad is appearance only, split spindle is not available on French Doors.

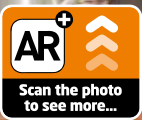

Available as inward or outward opening doors. Because our French door range is so vast, please contact us for the minimum and maximum sizes before you order your set.

**NOTE:** Available with UPVC and aluminium threshold on inward opening sets, and UPVC only on outward opening sets.



Flush, integrated two way lever, which throws the shootbolts and removes the need for a lever handle and cylinder to give the option to use our Italia Collection handles on both leaves, alternatively, go for lever operated!

Standard option is both doors to be lever handle operated.

# Stable Doors

All of our standard and many of the Italia Collection door styles are available as stable doors, in any of our colours on any side.

All of our stable doors come with a high security, fully adjustable multi-point locking system. They are also keyed alike, benefit from an internal thumb turn cylinder on the bottom half and have a latching security bolt as standard.



# Side Panels



Complement your property with a full range of matching full height and half side panels.





Half Moulded



Half Flat Grain



Quarter Moulded



Milano Side Panel



Milano



Brescia



Thornbury



Ludlow



Harlech



Available in all of our colour options!

Tenby



Nottingham

# Glass

A fine selection of stylish glass to help you personalise your choice of door. Whether modern or traditional you will find a glass design to really make your door stand out. Our full range of glass comes with Low E. Warmedge spacer and is Argon filled as standard

## Trio Square



## Diamond

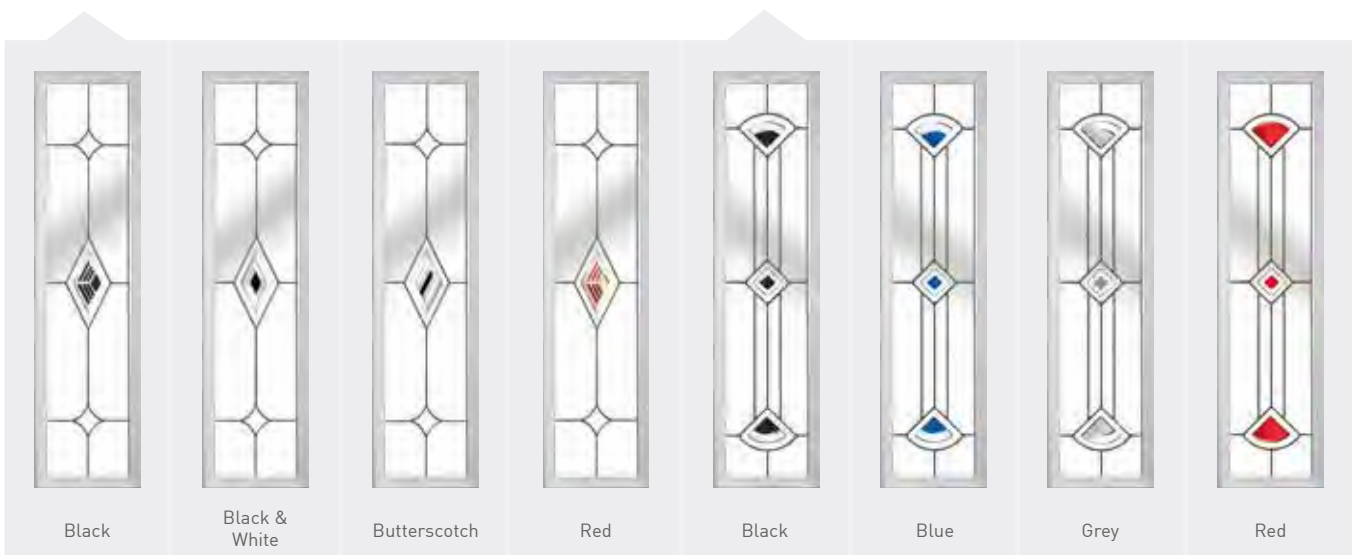

## Quad

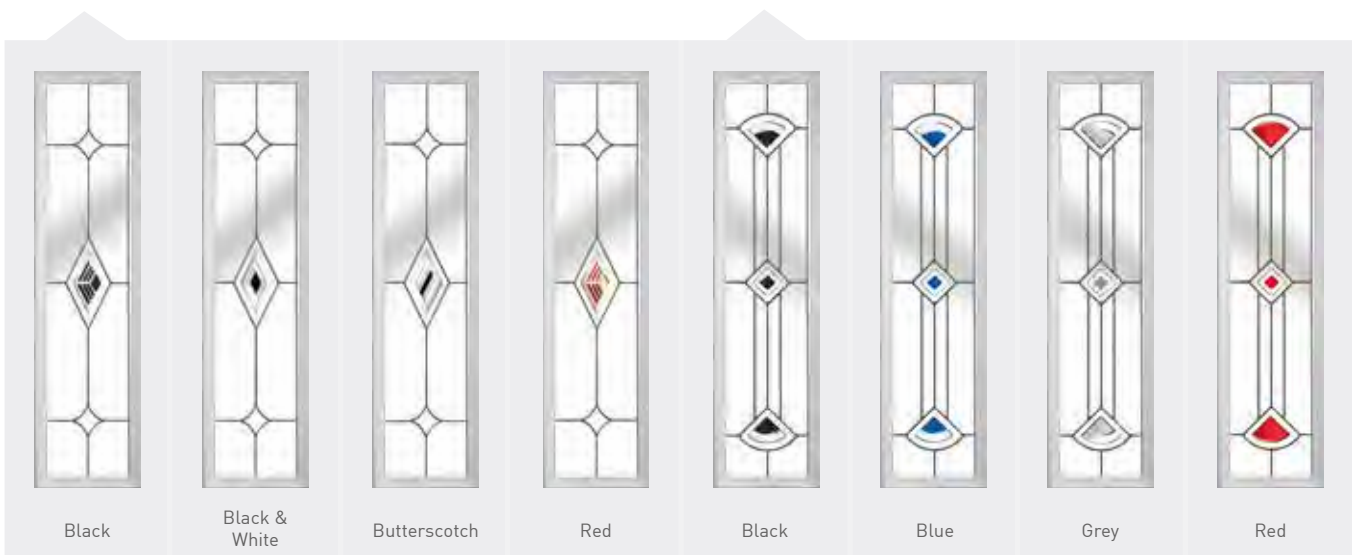

# New Glass Designs



Caledonian  
Rose Handed

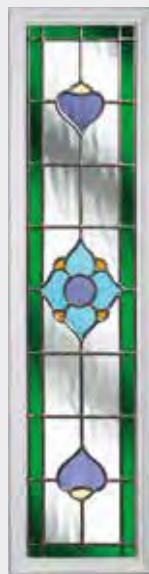

Dorchester \*



Etched Squares



Linear



London Etch  
Border



Matrix \*



Modena \*



Park Lane  
Bespoke



Zinc Art Star

Caledonian Rose - double glazed - Clear backing glass as standard

## Blind

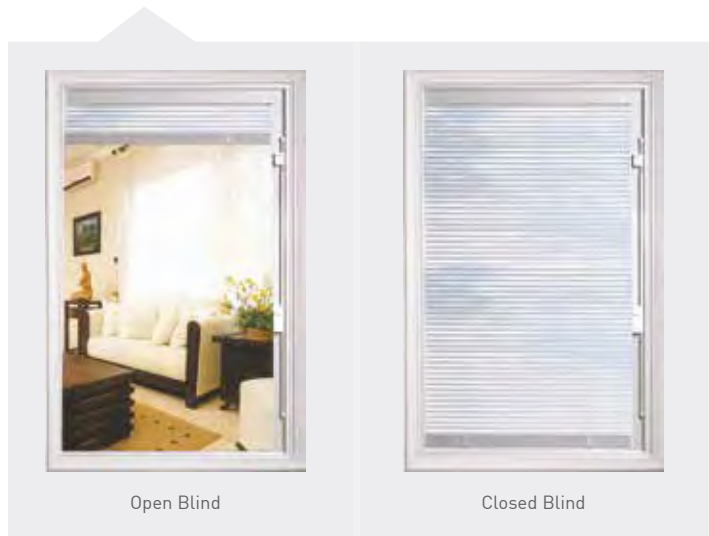

## Decorative



## CTB & Star

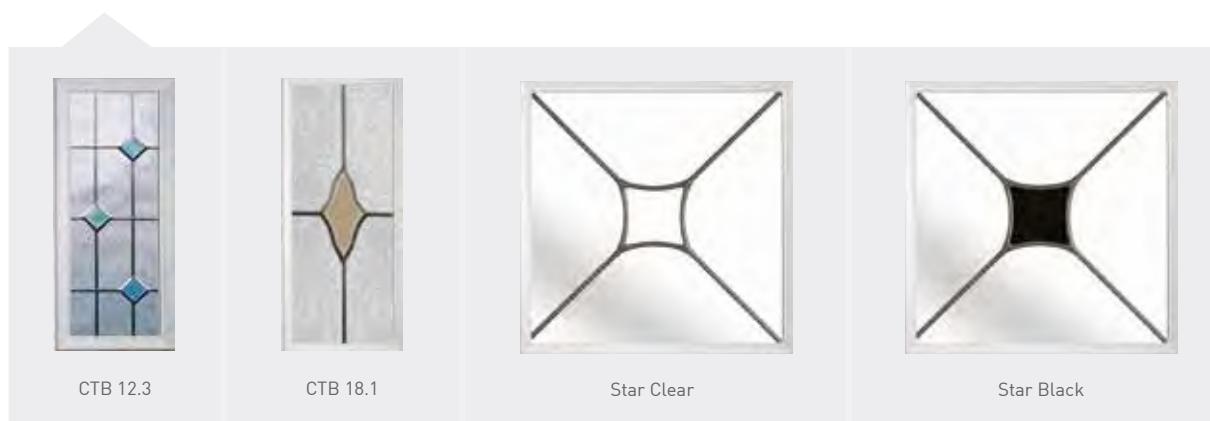

## CFT, CGB, CSB, CTB, CTL



### Glass designs key

CTL - Traditional Leaded designs

CTB - Glass bevel designs

CSB - Sandblast designs

Liquid Lead and Glass / tiles - Diamond, Quad, Square, CRL, Jewel.

Liquid lead, sandblast and stainless / glass tiles - With all of the above, a Pilkington backing glass should be selected.

Potomac, Waikato, Royale, Clarity, Elegance, Prairie, Simplicity, Brilliance, Abstract, Infinity, Reflections - Are all triple glazed and have no optional backing glass.

**\*Triple glazed glass**

# Accessories and Locks

A selection of beautiful accessories and high security locks to perfectly complement your choice of door. Whether contemporary or traditional you will find an accessory to really make your door stand out.



## Locks



### Heritage Slam Shut Lock

The Aesthetics of a traditional rim latch, but incorporating the latest high security multipoint lock, which activates the door automatically once the door is shut. Cylinder approximately 730 mm from the top of the door.

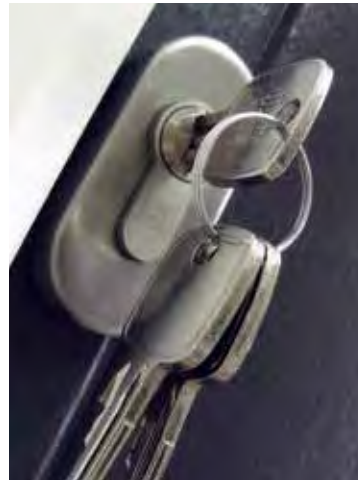

### Key Operated Multi

Customers who do not want a handle, can upgrade to our Key operated Multi point lock. Cylinder approx 1060mm from the top of the door.



### Key Operated Slam Shut Auto lock

The key operated Slam Shut lock is an automatic multi-point locking system has a magnetic trigger in the frame. It features two self-locking hooks to provide additional security and two sealing elements ensure correct closure. Cylinder approximately 1060mm from the door.



### The Largest Deadbolt in the UK!

On lever handle doors, we fit our Avantis Secured by Design lock, which has the industries largest 25.4mm deadbolt for added security. It also has built in compression and dampeners to give the smoothest operation on the market.

## Door knockers

Doctor

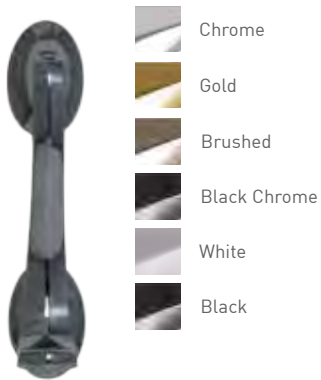

Premium 7" Doctor

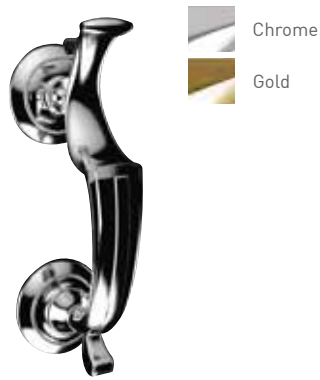

Urn



Pony Tail

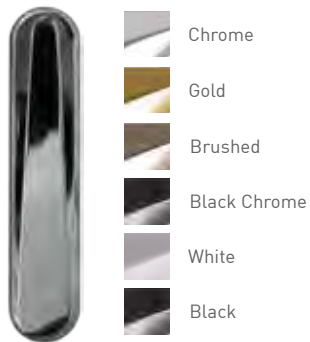

Stainless Steel



Lion

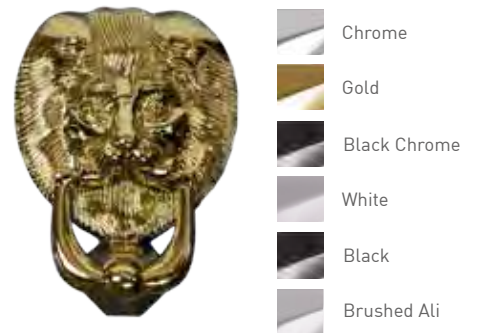

## Viewer



## Letterplates

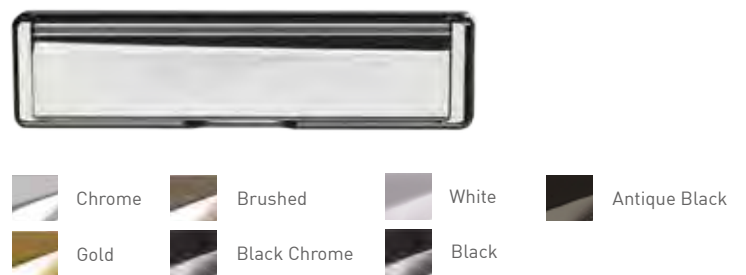

## Butt hinge

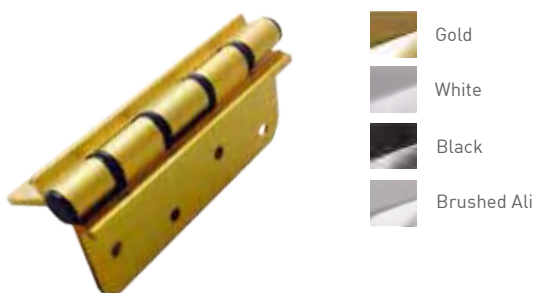

## Hinges

Our new slimline, Pas 23-24 tested, face fixed flag hinge is sleek and modern.

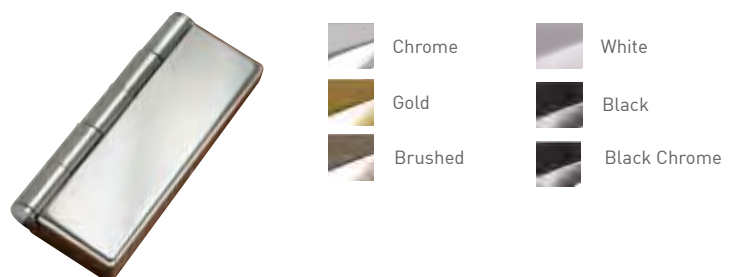







## Handles

A large range of premium quality handles to complement our doors. Available with a choice of a standard lever or one of the three exclusive options across the whole range of finishes.







### Swan Hardex



-  Chrome
-  Gold
-  Brushed
-  Black Chrome
-  White
-  Black
-  Antique Black







### Lever Hardex



-  Chrome
-  Gold
-  Brushed
-  Black Chrome
-  White
-  Black
-  Antique Black



### Lever Pad



-  Chrome
-  Gold
-  Brushed
-  Black Chrome
-  White
-  Black
-  Antique Black

## Door Knob





-  Chrome
-  Brushed

## Trojan Letterplates

Stainless steel specifically for coastal properties





-  Chrome
-  Gold
-  Brushed



## Trojan Urn

Stainless steel specifically for coastal properties





-  Gold
-  Chrome
-  Brushed



## Trojan Handles

Stainless steel specifically for coastal properties





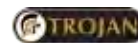

-  Gold
-  Chrome
-  Brushed



## Extra Security

### Security Door Guard



-  Chrome
-  Gold
-  Brushed
-  White
-  Black



### Stable Door Latch



Suited where possible



**The Yale Keyless Connected** smart lock gives you the freedom to secure your home without needing a Key. It is easy to use, and allows you to have complete control on how you unlock your door. NB: module to active smart lock not included.

-  Chrome
-  Gold





## Ironmongery

We have a range of stunning traditional knockers and handles that add a real touch of class.

### Traditional Avon Slimline

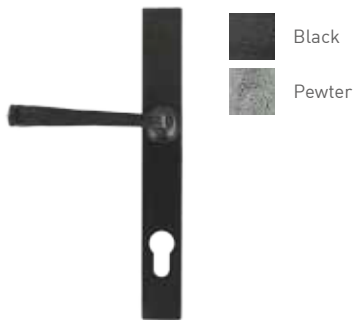

### Traditional Monkey Tail



### Traditional Cottage

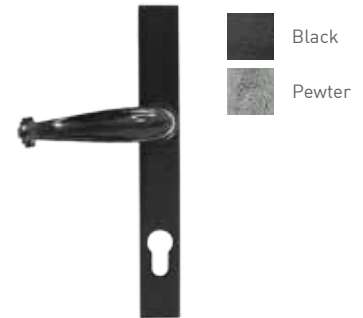

### Traditional Pull Knob



### Peardrop Knocker

Not available on Tenby 4 / Conway 3 / Ludlow Harlech / Nottingham 2



### Traditional Ring

Not available on Tenby 4 / Conway 3 / Ludlow Harlech / Nottingham 2



### Traditional Letterplate

Letterplate for illustrative purposes only



### Rim Pull

Available with the heritage lock

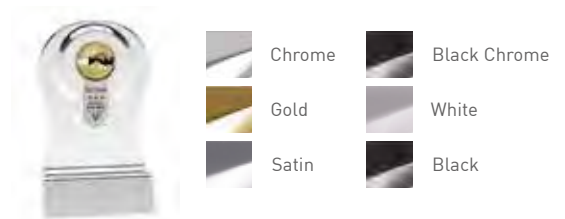

# Finishing Options

## OUTER FRAME OPTIONS

Which frame would you like? Choose from Kömmerling Chamfered C70 or Sculptured O70 outer frame.



Chamfered



Sculptured

## EDGE BANDING COLOURS

White as standard, brown on Rosewood and Schwarzbraun when coloured both sides, caramel on Golden Oak and Irish Oak when coloured both sides. For all other dual colour combinations, white edge band is used unless specified.

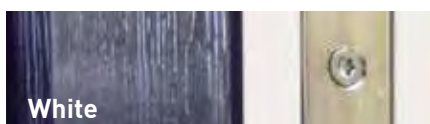

White



Brown



Caramel

## Thresholds

To allow for every circumstance we offer the largest range of door thresholds. All of our Stormguard aluminium thresholds are Part 'M' compliant within the latest Building Regulations for easy access.

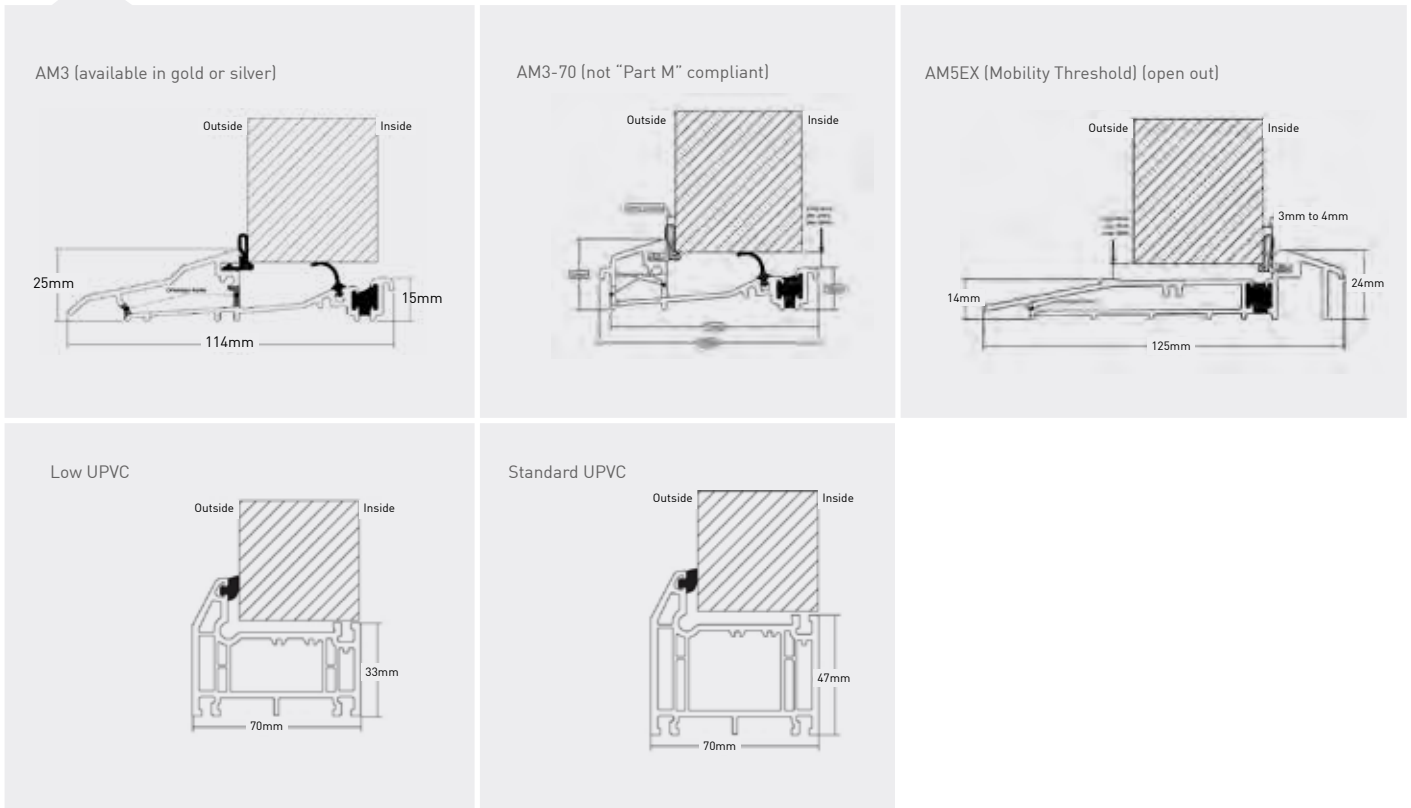

## Authentic deep nose cill for your **Solidor**

Available in 30mm or 50mm

Old imperial bricks varied in height, metric bricks are 65mm. Old timber cills were deep and often aligned with a course of bricks.

At 55mm The Radlington is a modern interpretation of a traditional cill, so if you are replacing your timber cill, the end result will look beautifully authentic.

Upgrade your Solidor with a Radlington cill today, available in 8 stunning Solidor colour colours to match your frame.

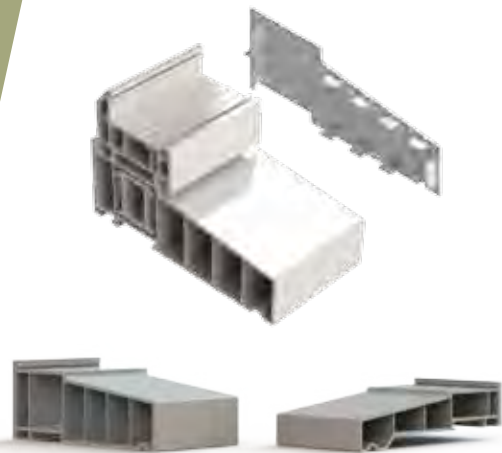

***"Compared to the generic slimline cills, there is simply no comparison."***

Gareth Mobley, CEO - Solidor







To create your perfect solidor go online  
or visit the App store

[www.doordesigner.solidor.co.uk](http://www.doordesigner.solidor.co.uk)



0808 163 6232 | [solidor.co.uk](http://solidor.co.uk)

Edition 12

